

*drive*

 DeVilbiss<sup>®</sup>  
HEALTHCARE

Bradshaw & Bradshaw Uncovered  
Community Care Bed Range

Instructions for use



This document is to be used in conjunction with the full instructions for use document. Read all warnings prior to using this guide. This Quick Reference Guide does not replace the full instructions for use.



## 1. Assembly/Disassembly

1. Apply Brakes.
2. Remove all R-Clips from Clevis Pins.
3. Remove all Clevis Pins from the Transport Stands.
4. Remove backrest section from Transport Stand.
5. Remove leg section from Transport Stand.
6. Separate Bed Ends from Transport Stand (unscrew bolts under Transport Stand).
7. Fit platform sections to the bed ends, tighten the fixings (one will be flush, the other offset) then assemble the platforms together. (screw bolts back in).
8. Replace all Clevis Pins
9. Replace all R-Clips
10. Fit Finger Kits to channels if separate.
11. Fully raise Side Rails.
11. Fit Side Rails to Finger Kits.

\* Assembly applicable to Uncovered Bradshaw variant.

## 2. Operation

- A - Backrest Position (Up/Down).
- B - Kneebreak section Position (Up/Down).
- C - Auto Contour (backrest and kneebreak together).
- D - Raise/Lower Bed.

- E - Foot Down Tilt.
- F - Head Down Tilt  
\*(Available with 10 button handset accessory only).
- G - Standard Leg Stay Function (Angle).

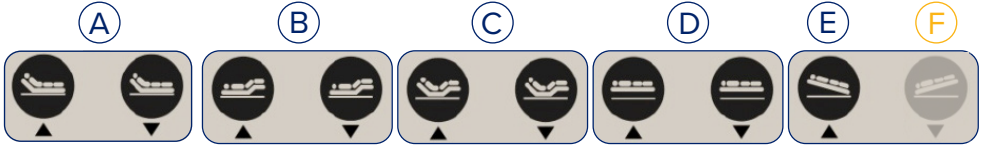

The Bradshaw range of beds are intended to be used with patients up to 178kg and of height in the range of 146 - 185cm or 146 - 201cm with extension. It is not intended to be used with patients of less than 40kg. The Bradshaw requires a power supply of 100-240V at 50/60Hz, with no more than 2A. The Bradshaw Low has a minimum and maximum mattress platform height 19.4cm lower than the standard height bed, but is operated the same way and thus these instructions still apply. Ensure labels on the bed are checked when routing cables from actuators to the control box to ensure functionality of the bed is as intended.

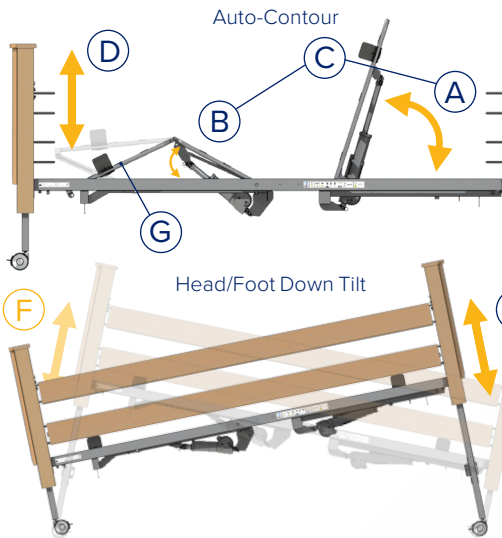

### Information for Regular Use:

#### Brake System:

The bed has four braked castors.

- To apply the brakes - Press the brake pedal down.
- To release the brakes - Lift the brake pedal up.

#### Side Rails:

When lowering the safety side rails, they must first be lifted to release the catch to allow them to slide down the channels. Always lower them gently to the bottom stop.

To raise the rails, lift the rail until it clicks into place. Refer to your safe side rail policy when using safety sides.

#### Leg Stay Function (G):

The calf section of the bed can be raised to enable the users calf to remain elevated. Once the knee break has been set at the desired angle, the leg stay angle can be set by lifting and releasing this section manually on the ratchet (if accessory is present).

To release, raise the leg section to the highest height and then lower

The handset is supplied with a lockout function which disables bed functions if they are deemed unsuitable for the occupant.

To lock/unlock a function, turn the handset over and insert the handset key provided into the recess. Turn to the required position (anti-clockwise to lock, clockwise to unlock). As the key is rotated the light will illuminate green to show the handset is unlocked.

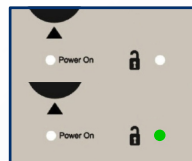

Handset Locking

The bed must not be used/moved if any fixings are missing or loose.

All cables must be loose and free of moving parts of the bed.

All moving parts are to be secured prior to moving the bed in transport stand.

All warning in the full instructions for use should be read and understood prior to using the bed.

A 9 button handset is provided as standard, if a 10 button handset is required, please see Section 18.

**Need Assistance? Call 01422 233 136 (8:30am - 5pm) or 0800 037 0234 (out of office hours)**

Drive DeVilbiss Healthcare Ltd. | Bradshaw

Quick Reference Guide | rev3

# CONTENTS

<b>1. INTRODUCTION</b> .....	<b>5</b>
<b>2. CONTACT INFORMATION</b> .....	<b>5</b>
<b>3. PRODUCT DESCRIPTION</b> .....	<b>6</b>
3.1 Environment .....	6
3.2 Intended Patient Group.....	6
3.3 Intended Use.....	6
3.4 Indications .....	6
3.5 Product Overview .....	6
3.6 Features .....	7
<b>4. SAFETY</b> .....	<b>8</b>
4.1 Warnings and Cautions .....	8
4.2 Risk Assessment .....	8
4.3 Contraindications .....	8
4.4 Bed Load .....	9
4.5 Training .....	9
4.6 General Warnings .....	10
<b>5. TRANSPORT AND STORAGE</b> .....	<b>11*</b>
<b>6. SYMBOL DEFINITION</b> .....	<b>12</b>
<b>7. PARTS IDENTIFICATION</b> .....	<b>14</b>
<b>8. BED ASSEMBLY AND PREPARING FOR USE</b> .....	<b>15*</b>
8.1 Removal from the Transport Stand .....	15*
8.2 Assembling the Bed .....	16*
8.3 Fitting the Electrical System .....	17*
8.4 Cable Routing .....	18*
8.5 Ancillary Product Cable Routing .....	18*
8.6 Fitting the Side Rails .....	19*
8.7 Side Rails and Mattresses .....	21*
8.8 Side Rail Safety .....	21*
8.9 Checking the Bed .....	22*
8.10 Fitting Ratchet .....	22*
8.11 Knee Break/Leg Section .....	23*
8.12 Lockout Function .....	24*
8.13 Installation/Preparing for Use .....	25*
<b>9. OPERATION OF THE BED</b> .....	<b>28</b>
9.1 Operational Limits .....	28
9.2 Brake System .....	28
9.3 Operating the Side Rails (when fitted) .....	29
9.4 Electrical Operation .....	29
9.5 Side Rail Lockdown Functionality .....	31
9.6 Uncovered Bed Ends .....	32
<b>10. ASSEMBLY ONTO THE TRANSPORT STANDS</b> .....	<b>32*</b>
<b>11. POWER FAILURES</b> .....	<b>33</b>
<b>12. BATTERY CHARACTERISTICS</b> .....	<b>35</b>
<b>13. DECONTAMINATION</b> .....	<b>36*</b>
13.1 Cleaning and Disinfection Guidelines .....	36*
13.2 Steam Cleaning .....	37*
<b>14. MAINTENANCE</b> .....	<b>38*</b>
14.1 General Inspection .....	38*
14.2 Fault Finding .....	38*
14.3 Servicing .....	39*
<b>15. DISPOSAL OF PARTS</b> .....	<b>40*</b>
<b>16. SPECIFICATION</b> .....	<b>41</b>
16.1 Bed Data .....	41
16.2 Electrical Data .....	42
<b>17. ELECTROMAGNETIC COMPATIBILITY (EMC)</b> .....	<b>43</b>
<b>18. ACCESSORIES</b> .....	<b>44</b>
18.1 Mattress/Side Rail Compatibility Chart .....	47
<b>19. SERVICE LIFE</b> .....	<b>50</b>
<b>20. WARRANTY</b> .....	<b>51</b>



Warning

\* Highlighted pages are for authorised personnel reference only, if in doubt contact Drive DeVilbiss Healthcare Ltd. or your local distributor.

## 1. INTRODUCTION

---

Thank you for purchasing this product. These instructions for use should be read carefully before operating the bed. Please ensure that you understand all instructions, if you have any questions concerning the operation or maintenance of the bed please contact your provider/supplier who will provide you with expert professional advice. Drive DeVilbiss Healthcare Ltd. recommend the bed is assembled and maintained by Drive DeVilbiss Healthcare Ltd. service engineers or qualified personnel.

## 2. CONTACT INFORMATION

---

For assistance in setting up, using, maintaining your bed, to report unexpected operation or for any service, warranty, sales or customer service information regarding this product please contact your provider or if in doubt contact Drive DeVilbiss Healthcare Ltd. at the following address:

Drive DeVilbiss Healthcare Ltd.  
Sidhil Business Park,  
Holmfield,  
Halifax,  
West Yorkshire  
HX2 9TN  
United Kingdom

### **Service & Maintenance**

Tel: +44 (0)1422 233136

Fax: +44 (0)1422 233010

### **Spares**

Tel: +44 (0)1422 233138

Fax: +44 (0)1422 233010

### **Sales**

Tel: +44(0)8450600 333

Fax: +44(0)8450600 334

[info@drivedevilbiss.co.uk](mailto:info@drivedevilbiss.co.uk)  
[www.drivedevilbiss.co.uk](http://www.drivedevilbiss.co.uk)

Any serious incident that occurs in relation to the device should be reported to Drive DeVilbiss Healthcare Ltd and the competent authority of the Member State in which the device is used. Please quote the product SN number on all correspondence. This can be found on the identification labels, which are located on the outside of the backrest section frame, on the outside of the leg section frame, and on the lower section of each bed end.

For Service & Support outside the United Kingdom & Northern Ireland please contact the local distribution company from where this equipment was purchased. Failure to do so may result in the manufacturer's warranty becoming void.

## **3. PRODUCT DESCRIPTION**

---

### **3.1 Environment**

Your bed is intended for use in the following environments:

- A domestic area where the bed is used to alleviate or compensate for an injury, disability or disease.
- A long term care area where medical supervision is required and monitoring is provided if necessary (e.g. nursing homes, rehabilitation facilities, geriatric facilities etc.).

### **3.2 Intended Patient Group**

The bed frame is intended for an adult who is up to 178kg in weight. A lower (or upper) age limit is not defined as it depends on the physical size of the patient in relation to the various proportions and gaps around the bed frame. Patients must be in excess of 146cm in height ranging up to 201cm (bed extended) and have a BMI greater than 17.

The bed frame is intended to support a single adult.

### **3.3 Intended Use**

The intended use of the bed is to support the weight of the patient as defined in section 3.2, whilst sleeping or resting and to assist the end user to gain and/or maintain a suitable position.

### **3.4 Indications**

To assist in the care and/or comfort of the patient or care provider when the bed is used in the environments intended in section 3.1.

### **3.5 Product Overview**

The Bradshaw range of beds are intended to be plugged into a permanent mains supply. A battery backup accessory is available for such times that a mains supply is not available or reliable. A low height version of the bed is also available, the low height bed has a minimum and maximum mattress platform height 194mm lower than the standard height bed.

The bed has one handset, intended for use by both the patient and carer, which provides the carer with the ability to lock out the use of bed functions as necessary to reduce the risk of accidental operation. It is the carer's responsibility to determine that the patient is both mentally and physically capable of operating the handset with minimal risk of personal injury.

The handset operates an electronic linear actuator system, which is controlled via a central control box. The actuators are attached to the moving parts of the bed frame allowing the bed to be operated via the use of the handset.

Two powder coated steel bed ends support the mattress platform frame, the electrical system and a set of side rails (when fitted) to provide patient protection; the bed has a safe working load of 215kg. The bed is manoeuvrable via the aid of four individually braked castors which are attached to the bed ends, however it is not designed for patient transportation. The bed can be disassembled into four separate sections, which can be assembled onto the transport stands provided with the bed, aiding transportation and storage.

### 3.6 Features

- Electrically operated backrest, height adjustment and leg rest angle.
- Auto regressing backrest.
- Electrically operated foot down tilt.
- Auto contour – simultaneous adjustment of the backrest and leg rest sections.
- Battery backup functionality (with BED/BATTERY/S only).
- Patient handset with lockout.
- Optional integral full length side rails.
- Can be broken down into four separate sections.
- Transport stands to aid storage and bed transportation.



**Warning**

- The 9 button handset provided omits the head down tilt function for safety reasons. If a head down tilt function is required a replacement handset can be purchased featuring this function. Please refer to section 18 for the part code, and refer to the contact information in section 2 to order or to request further information – Drive DeVilbiss Healthcare Ltd. recommend the use of the standard 9 button handset when the bed is being used in a domestic environment.
- The Bradshaw Low does not meet the upper height or underbed requirements of EN 60601-2-52, if patient or carer requirements are such that the height range is deemed to pose a potential hazard the Bradshaw should be used instead, please refer to the contact information in section 2 to request further information.

## 4. SAFETY

---

### 4.1 Warnings and Cautions



**Warning**

Warnings in these instructions for use highlight potential hazards that if disregarded could lead to injury or death.



**Caution**

Cautions in these instructions for use highlight potential hazards that if disregarded could lead to equipment damage or failure.

### 4.2 Risk Assessment

Before a patient uses the bed a risk assessment must be performed on a patient by patient basis. The risk assessment should include, but is not limited to:

- Entrapment.
- Falling out of the bed.
- Small adults (and children).
- Patients who lack capacity.
- Unauthorised people with access to the bed.
- Use of side rails and other accessories.

### 4.3 Contraindications

Patient conditions for which the use of the Bradshaw and Bradshaw Low bed is a contraindication are as follows:

- Cervical or skeletal traction.
- Unstable spinal fractures - If bed functions remain unlocked.
- General skeletal fractures - If relevant bed functions remain unlocked.
- Mental capacity not sufficient to operate handset functions safely - If bed functions remain unlocked.
- Confused, agitated or restless - If side rails fitted and/or in raised position.
- Exceeds maximum patient weight of bed.
- Less than 146cm in length.
- BMI less than 17.
- Less than 40kg in weight

Other contraindications may be relevant which are specific to the patient or care environment.



## 4.4 Bed Load

Safe working load: **215kg (34 stone)**

Maximum patient weight: **178kg (28 stone)**

- Safe working load is the sum of:
- Patient mass.
- Mattress mass.
- Accessories mass.
- Mass supported by the accessories (excluding patient mass).



**Warning**

The maximum loads shown above are for the bed to be occupied by one person only. The bed is not designed to take the weight of visitors sitting on the side of the bed. Additional weight could damage components or cause the bed to become unstable, potentially causing injury.

## 4.5 Training

All professional users are to be suitably familiar with the bed's functionality and its limitations prior to use. Patients are to be familiarised with handset and bed functionality by the professional user at the earliest opportunity, ideally before using the product.

It is the responsibility of the professional user to ensure they are suitably qualified to use the bed and any associated accessories safely and correctly. If these instructions for use are not deemed sufficient and the need for training is required please contact Drive DeVilbiss Healthcare Ltd. or your local provider (see section 2) who will be able to discuss training options with you.

## 4.6 General Warnings



**Warning**

- The bed is to be installed and put in to service in accordance with the information provided in these instructions for use.
- The bed is typically not suitable for child use, if it is to be used for child occupancy ensure a risk assessment has been undertaken taking in to account the proportions of the child and dimensions of the bed frame.
- The bed is not suitable for occupants who are less than 146cm in length - If in doubt please contact your provider or Drive DeVilbiss Healthcare Ltd. for further advice.
- The bed is not suitable for occupants who weigh less than 40kg - If in doubt please contact your provider or Drive DeVilbiss Healthcare Ltd. for further advice.
- The bed is not suitable for occupants who have a BMI less than 17 - If in doubt please contact your provider or Drive DeVilbiss Healthcare Ltd. for further advice.
- Misused electrical equipment can be hazardous.
- Accessories that have not been approved or designed for use with the bed are not be used - a hazard could be introduced due to product combination incompatibility.
- Modification of the bed frame is not allowed without the permission of Drive DeVilbiss Healthcare Ltd. – a hazard could be introduced.
- Electrically operated beds should not be used in the presence of flammable gasses or used in oxygen rich environments - risk of explosion/fire.
- Keep the bed away from sources of heat and naked flames (e.g. cigarettes, electric fires, fan heaters etc.) - risk of explosion/fire.
- Bed functions must be locked out if there is any doubt about the ability of the patient to operate the bed safely.
- If children, adults who lack capacity or even pets pose a potential risk of intentional or unintentional tampering with the bed its suitability for use is to be considered during the initial patient/product risk assessment.

## 5. TRANSPORT AND STORAGE

The following conditions should be followed when transporting and storing the bed:

- To save space, the bed should be stored on the transport stand.
- Ensure all fixings are in place and secured when transporting.
- The bed should always be stored on a flat and level floor.
- The bed ends should be set to minimum height.
- Side rail components, if applicable, (not including side rails) to be kept in the channels on the bed ends (or stored safely together).
- The brakes should be applied.
- All profiling sections should be secured with supplied cable ties (or similar).
- All functions on the handset should be locked out.
- The bed should be covered to protect it from fluid ingress, dirt, dust etc.
- Beds should not be stored one on top of another or on their side.

	Operational Limits	Transport/Storage Limits
Ambient Temperature	+10°C to +40°C	-20°C to +50°C
Humidity	30% - 75%	30% - 75%
Atmospheric Pressure	800 to 1060hPa	800 to 1060hPa
Altitude	≤ 2000m	≤ 2000m



**Warning**

- The bed is not intended for patient transport, it is not to be moved out of the room it is located in with a patient occupying the bed - risk of patient/carer injury. If the bed is to be moved within the room with an occupant in the bed a risk assessment in line with local health and safety policy is to be undertaken in order to ensure that neither staff or patients are put at risk when moving the bed; this is dependent on the situation and load on the bed.
- If transporting the bed whilst on its transport stand ensure a risk assessment in line with local health and safety policy is undertaken to ensure that the staff are not put at risk when moving the bed, especially in regards to moving up/down inclines and uneven surfaces.
- The bed must never be moved on the transport stand with the grub screws missing or sections not secured - risk of bed collapse.
- To prevent the risk of cross infection, when removing a bed from an end user's residence ensure that all activities in relation to the bed are carried out using disposable gloves and that they are then discarded appropriately, unless it can be verified that the bed and any associated accessories have been suitably cleaned and disinfected prior to collection.
- On the return of a bed from an end users residence, prior to putting the bed into storage ensure it has been cleaned and disinfected in line with the local infection control policy and/or as defined in section 13 of these instructions for use.



**Caution**

- The bed is not to be pushed over thresholds - if done so damage to the frame could occur.
- Cable ties (or similar) used for storage should be removed after assembly and before operation - damage to the frame could occur due to restriction.

## 6. SYMBOL DEFINITION

---

The following symbols are found on this bed:



Warning  
Beware of potential hazard

---



Caution  
Beware of potential product damage

---



Refer to instructions for use - Recommended  
Failure to read the instructions for use could introduce a hazard

---



Refer to instructions for use - Mandatory  
Failure to read the instructions for use could introduce a hazard

---



Conforms to the Medical Devices Regulation 2017/745

---



Importer

---



Total bed weight  
Including safe working load

---



Care is to be taken when pushing the bed over thresholds when on transport stands - Risk of tipping

---



Maximum patient weight  
Refer to section 4.4

---



Safe working load  
Refer to section 4.4

---



Mass greater than 20kg

---



EC Representative

---

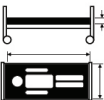

Mattress suitability  
Refer to section 18

---



Mattress strapping suitability

---



Detachable side rail suitability  
Use of an incorrectly specified or positioned side rail could introduce a hazard.



Minimum patient weight



Minimum patient BMI



Minimum patient height



Atmospheric pressure limit



Humidity limit



Temperature limit



Serial Number



Country /date of manufacture



Manufacturer



Catalogue number



Medical device



Class II electrical device

The user/occupant is protected by at least two layers of insulation between the current carrying parts (e.g. control box and mains cable) and the metal accessible parts – If damage is noticed to any electrical component, turn off at the mains and contact your provider or Drive DeVilbiss Healthcare Ltd. immediately.



Type BF applied part

Applied Part: The parts of the bed that come into physical contact with the user / occupant in order for the bed to carry out its intended function (refer to section 16.2 for a list of applied parts).

Type BF: Applied parts which are electrically isolated from earth and other parts of the medical equipment - Complying with specific requirements for protection against electric shock to EN 60601-1.

## 7. PARTS IDENTIFICATION

(Image shown of Bradshaw with integral wood side rails, parts identification for low height & uncovered Bradshaw beds is as per the standard bed.)

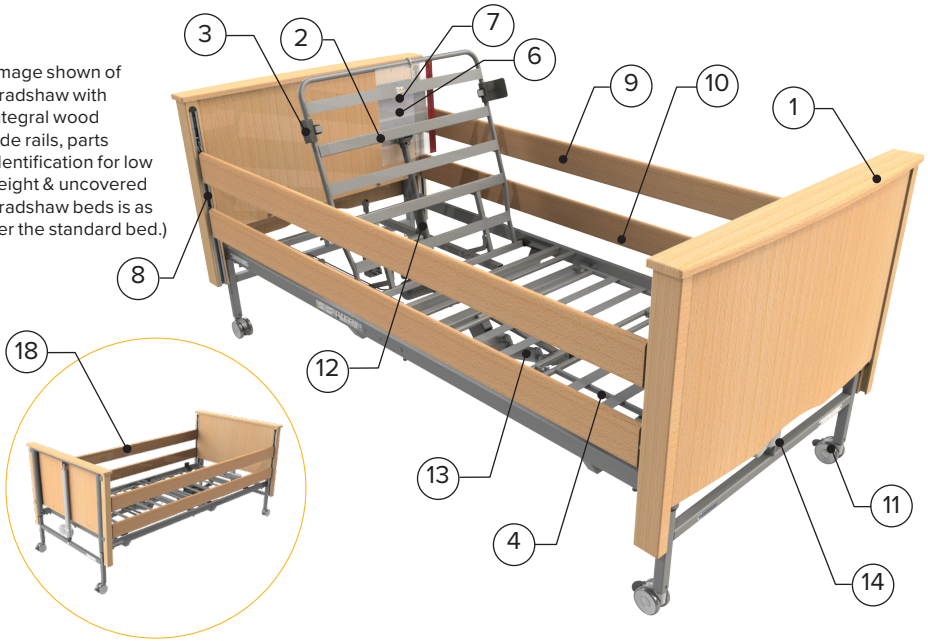

1. Bed end x 2
2. Backrest section x 1
3. Mattress side retainer x 4
4. Leg section x 1
5. Transport stand x 2
6. Handset lock key x 1
7. Handset x 1
8. Side rail channel (if fitted) x 4
9. Upper side rail (if fitted) x 2
10. Lower side rail (if fitted) x 2
11. Braked castor x 4
12. Control box/Backrest actuator x 1
13. Leg rest actuator x 1
14. Bed end actuator x 2
15. Allen key storage location x 1
16. Head section re-usable cable tie location x 1
17. Leg section re-usable cable tie location x 1
18. Bradshaw standard height bed with uncovered bed ends

Head Section

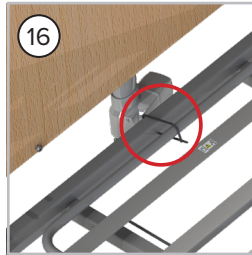

Leg Section

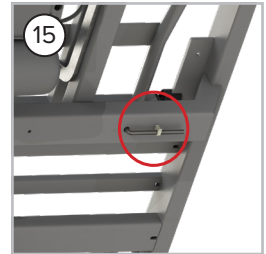
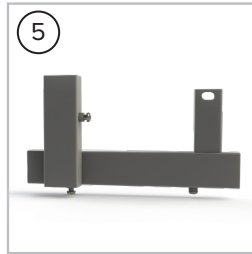
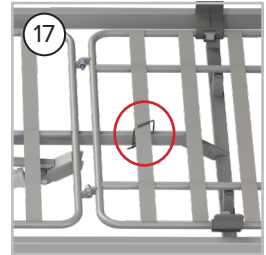

## 8. BED ASSEMBLY AND PREPARING FOR USE



### Warning

- Before attempting to assemble the bed ensure these instructions have been read and fully understood.
- Only qualified personnel are to assemble and prepare the bed for use, if in doubt contact Drive DeVilbiss Healthcare Ltd. or your local distributor.
- Ensure a risk assessment in line with local health and safety policy is undertaken to ensure that staff are not put at risk when performing assembly activities.
- Take care when disassembling the bed from the transport stand, the sections are of considerable weight.

### 8.1 Removal from the Transport Stand

The assembly procedure is as follows:

- Clear the area intended for the bed of any obstructions and ensure the surface is level.
- Apply the brakes to the castors.
- Remove the clevis pin, 'R' clip and plastic spacer that secure each transport stand to the leg section (8.1.1). These parts will be required when assembling the bed sections together.
- Loosen the top grub screws with the Allen Key supplied under the backrest platform on both transport stands. (8.1.2).
- Lift the leg section off the transport stands followed by the head section and carefully place them flat on the floor.
- Loosen the bottom grub screws which secure the bed end to the transport stand on one side only (8.1.3).
- Pull this same bed end away from the transport stands and place carefully against a wall or on the floor. If placing against a wall ensure the castor brakes are applied.

**Note: when the transport stands are pulled away neither bed end will be supported.**

- Now loosen the remaining screws on the transport stands and carefully pull the other bed end away. The bed has now been separated into its constituent parts.

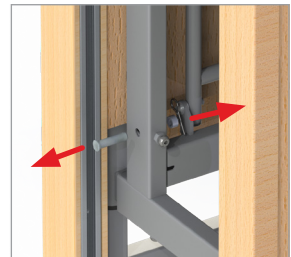

8.1.1 Clevis pin, spacer, and 'R' clip removal

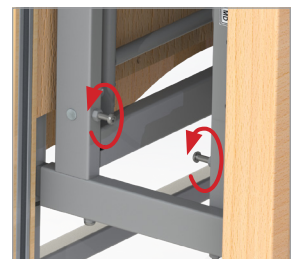

8.1.2 Top grub screws on the transport stand



8.1.3 Bottom grub screws on the transport stand

## 8.2 Assembling the Bed

- Whilst supporting one of the bed ends, lift one of the mattress platform halves and engage onto the bed end (8.2.2). Adjust the position of the mattress platform half if necessary to ensure it is located centrally onto the bed end. Tighten the grub screws to lock into position (8.2.1). **Note: If this action is being undertaken by a single person Drive DeVilbiss Healthcare Ltd. recommend that the castors are braked before assembly commences.**
- Repeat for the remaining bed end and mattress platform half.
- Release the brakes on the castors on both bed ends.
- Bring both halves of the bed together (8.2.3) and align each section so that the spigots in the backrest section locate into the open tube ends in the leg section. Now pull the two sections together. \* Assembly steps are applicable to Uncovered Bradshaws.
- Place the clevis pins through the holes by both central joints with the head of the pin on the outside of the bed. Place the plastic spacer over the end of the pins and insert the 'R' clips from the top of the bed through the hole in the pin (8.2.4) and **tighten the two grub screws.**

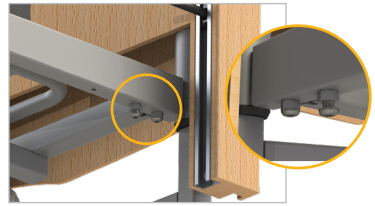

8.2.1 Bed end and backrest assembled



8.2.2 Bed end and backrest section assembled



8.2.3 Bring assembled bed halves together

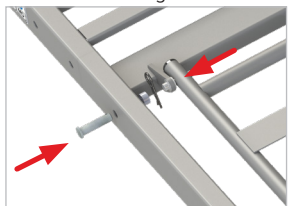

8.2.4 Clevis pin, spacer, and R clip fitting



Warning

The bed must never be used if the grub screws and/or clevis pins and associated 'R' clips are loose or missing - risk of bed collapse.



Caution

Ensure all tie wraps/hook and loop tape (or similar) securing any of the sections in place are removed prior to operation - damage to the frame could occur.

## 8.3 Fitting the Electrical System

- Remove the retaining cable cover to the control box (screwdriver required) (8.3.3). Plug the actuator and handset cables into the control box see 8.3.1 for detail of the control box label.



**Note: The plugs only fit into the ports in one orientation. Ensure the cables are plugged fully into the control box.**



**Warning**

- The two bed ends are identical however plugging the actuators into the correct ports is important to ensure the bed ends operate as intended. Tilt function will not work as intended if incorrectly connected.
- Always disconnect the bed from the mains power supply prior to connecting or disconnecting any cables to the control box.

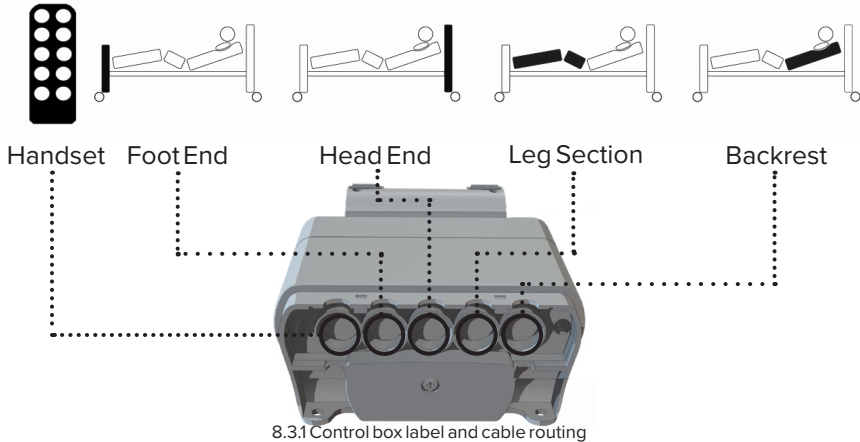

8.3.1 Control box label and cable routing

- Once all the cables are connected they are to be secured in place by re-attaching the supplied cable cover to the control box (8.3.3). If removed, the battery cover is fastened into place using the supplied screw (8.3.2). The mains cable exiting the control unit should now be connected to the power supply plug. Take the 2 plugs and push them together, ensuring the connection has been fully made before plugging into the mains (8.3.4)
- Drive the bed to its maximum height then secure the actuator cables in the twist clips under the mattress platform (refer to section 8.4). Ensure each bed end actuator cable has enough free cable to allow full movement of the actuator.



Unscrew/screw the battery cover into place by using the screw provided

8.3.2 Fitting battery cover



Cable cover unclips/clips into place

8.3.3 Fitting cable cover





8.3.4 Plugging the bed into the mains

## 8.4 Cable Routing

The cables are to be routed on the bed frame as shown below:

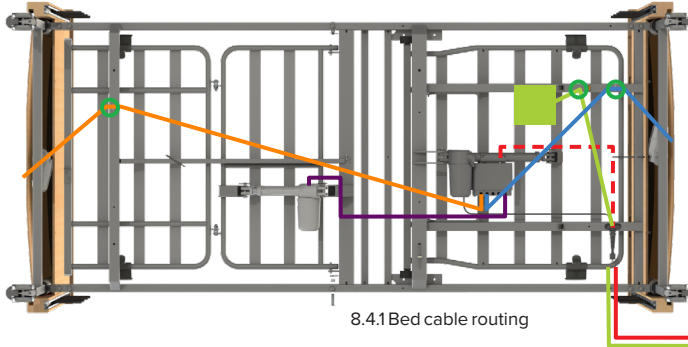

- Cable Clips
- Mains Cable (default)
- Head End Actuator Cable
- Leg Section Actuator Cable
- Foot End Actuator Cable
- Battery Backup Mains Cable (BED/BATTERY/S only)

8.4.1 Bed cable routing



**Warning**

Ensure all cables, in particular the mains cable, are free from moving parts and are not under excessive tension to avoid cable damage - Damaged cables can create a risk of electrocution/fire.

## 8.5 Ancillary Product Cable Routing

When fitting ancillary electrical equipment the ancillary mains cable is to be routed using the twist cable clips located underneath the bed. These clips are shared with the bed's actuator cables.

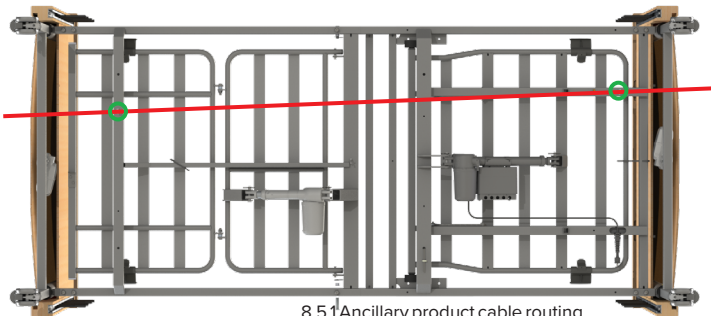

**Ancillary product cable routing**

8.5.1 Ancillary product cable routing



**Warning**

Ensure all ancillary cables are free from moving parts and are not under excessive tension to avoid cable damage - damaged cables can create a risk of electrocution/fire.

## 8.6 Fitting the Side Rails

Ensure the side rails used are the correct length for the beds length (extended length or standard length side rails).

Raise the bed to approximately the midpoint of its height range. Refer to section 9.4 for details of handset operation.

Wooden integral side rails are used for illustrative purposes. Other side rails and accessories are available (see section 18).



**Warning**

If there is any doubt about the assembly of the side rails contact the provider of the equipment or Drive DeVilbiss Healthcare Ltd., incorrectly fitted side rails can lead to death.

**Note: If the side rail finger blocks are already located inside the side rail channels, remove the finger blocks from just one end of the bed, then proceed to assembly stage 4 below.**

1. Unscrew the cap head screws located at the bottom of each side rail channel.
2. Clip the side rail wire over the top side rail block, identified by the metal release latch at one end.

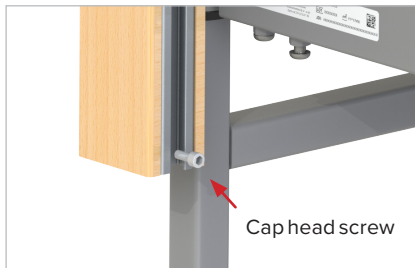

8.6.1 Cap head removed

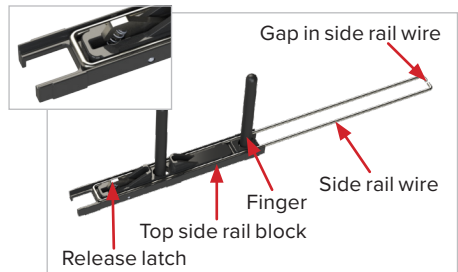

8.6.2 Top side rail block and wire assembly

3. Insert the top side rail block into one of the side rail channels until it latches in the lowest position; note the correct orientation of the block (release latch to top).
4. Slide a side rail over the fingers in the top side rail block. This side rail should not have a bush between the rail and the finger kit.



8.6.3 Top side rail block latched



8.6.4 Top side rail inserted  
(Side rail shown for reference.  
Actual product may vary.)

5. Connect another side rail wire and top side rail block together as described in step 2, and insert the fingers into the vacant end of the top side rail. Lift this top side rail block into the channel until it latches in place.
6. Release the latch on one of the top side rail blocks and steadily lower to allow sufficient space for the bottom side rail block to clip over the lift wire. It is essential that the lift wire is clipped into the bottom side rail block in the correct location.



8.6.5 Top side rail assembled

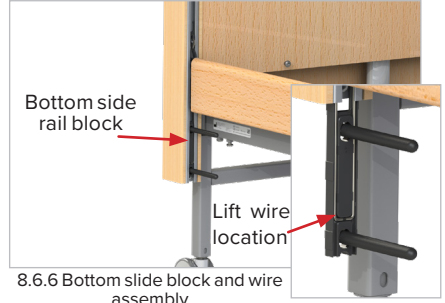

8.6.6 Bottom side rail block and wire assembly

7. Slide the second side rail over the fingers in the bottom side rail block. This side rail must have a bush between the side rail and finger kit. Raise the side rail so it latches in place at one end.
8. Repeat for the other end of the bottom side rail.

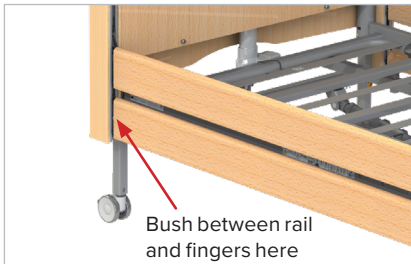

8.6.7 Bottom side rail inserted



8.6.8 Side rail raised

9. Reinsert the cap head screw into the bottom of each side rail channel to secure the channels in place.
10. Repeat the process for the other side of the bed. Check the side rails operate correctly to confirm that they are correctly assembled.

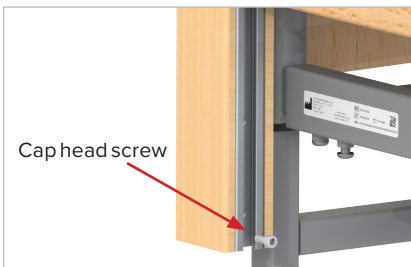

8.6.9 Cap head re-inserted



8.6.10 Side rails fitted

### **8.7 Side Rails and Mattresses**

The Bradshaw can be specified with side rails; refer to section 18 for a comprehensive list of options. When specifying a mattress and side rail combination a clinical assessment of the patient's needs must be carried out in line with local policy.



**Warning**

- Ensure that any mattresses used are of the correct size and type and have been fitted correctly (see section 18) – incorrect mattress specification could lead to an entrapment and/or falls hazard.
- Ensure the side rails (if fitted) are compatible with the mattress and bed combination (see section 18) - incorrect product combinations could pose an entrapment hazard.

### **8.8 Side Rail Safety**

Drive DeVilbiss Healthcare Ltd. only recommends the use of Drive DeVilbiss Healthcare Ltd. side rails with Drive DeVilbiss Healthcare Ltd. beds. Drive DeVilbiss Healthcare Ltd. does not recommend the use of the Bradshaw bed and the associated side rails when caring for individuals who are less than 146cm in length - It is the equipment provider's responsibility to ensure suitability for use.



**Warning**

- Whilst every care has been taken to ensure that the design of Drive DeVilbiss Healthcare Ltd side rails meet the relevant safety standards, beds fitted with side rails can still pose a potential risk of death from entrapment and/or asphyxiation.
- All staff responsible for the purchase, selection for use, and the adjustment of bed side rails should be aware of the potential risk of entrapment and asphyxiation when a bed is occupied.
- Care must be taken when positioning and adjusting side rails to ensure that any spaces between the side rails, mattress or bed frame will not allow entrapment of the occupant's head or body. In addition, consideration should be given to the size and physiological condition of the occupant and an assessment undertaken to ensure that the spacing between the bars of the side rails are not wide enough to present a potential risk of entrapment and/or asphyxiation. All staff responsible are to be aware that increased vigilance is required when nursing patients in beds fitted with side rails.

### 8.9 Checking the Bed

The bed is now fully assembled. Before it is put into use, ensure the bed has been correctly assembled by carrying out the following checks:

- Are the grub screws on the corners of the bed fully tightened?
- Are the two central mattress platform grub screws fully tightened?
- Have the two clevis pins been passed through the bed's central join and secured with 'R' clips and spacers?
- Has all packaging been removed, e.g. cable ties securing the platform sections?
- Are all four mattress retainers present? Any missing retainers should be replaced before the bed is used.
- Are the cables free of all moving parts of the bed and is there sufficient free cable to allow for movement?
- Is the bed clear of obstructions?
- If fitted, are the fixings securing the integral side rail channels fully tightened?
- If fitted, do the integral wooden side rails raise/lower smoothly and lock automatically when raised to the highest position?
- Has a risk assessment been performed on the suitability of the bed (and any ancillary equipment) for the user?

### 8.10 Fitting Ratchet

The Bradshaw can be specified with a ratchet to adjust the leg section angle; refer to section 18 for a comprehensive list of optional accessories. The ratchet is supplied with a spanner, you will also need two Allen Keys. One is provided with Bradshaw bed; refer to section 7 for Allen Key location. The other is a 6mm Allen Key.

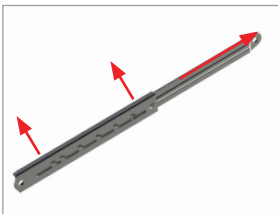

1. Fully extend the ratchet, before offering up to the bed (note ratchet orientation).

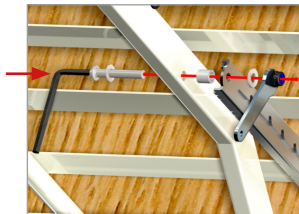

2. Place the steel washer onto the screw before putting through the hole on the leg section platform, facing in towards the actuator. Add the white spacer to the screw, slide the ratchet over the screw until flush with the white spacer (note ratchet orientation). Add a steel washer, using a 6mm Allen key and the spanner provided tighten into place with the nyloc nut. This end of the ratchet is now fixed into position.

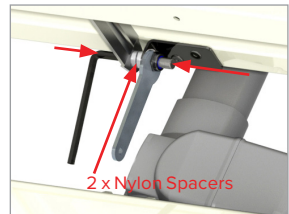

3. Place one of the steel washers over the remaining screw. Put through the ratchet facing in towards the actuator. Add the two white nylon spacers between the ratchet and bracket on the leg section. Add remaining steel washer on the nut side of the leg section bracket. Using the Allen key and spanner provided tighten into place with the nyloc nut. The ratchet is now fixed into position, check operation before use.

## 8.11 Knee Break/Leg Section

**Note:** The operation of the leg section is dependent on the position of the ratchets as detailed below.

When the leg section function on the handset is operated the height or angle of the leg section is adjusted, depending on whether or not the leg section ratchet is engaged.

Leg section angle adjustment:



8.11.1 Leg section angle adjustment

Leg section height adjustment:



8.11.2 Leg section height adjustment

**To set the bed so that the leg section angle adjustment operates:**

- Press the knee break button on the handset to fully lower the leg section. The ratchet will automatically default to the angle adjustment setting when the leg section is fully lowered.

**To set the bed so that the leg section height adjustment operates:**

- Press the leg section button on the handset to raise the leg section to maximum height.
- Taking hold of the bottom of the foot section, **slowly** lift the section manually so the ratchet engages, stopping when the required angle has been reached.

**Note:** The ratchet will reset if lifted to its full extent, and will therefore not engage the leg section height adjustment.

- The leg section will now be raised as the leg section is driven up/down. The ratchet will automatically reset when the leg section is fully lowered again, defaulting the leg section to the angle adjustment setting.



**Warning**

Before attempting to engage/disengage the ratchet mechanism either:

- Ensure there is no load on the foot section or support the foot section with a second able bodied person.



**Caution**

The leg section is only to be used for the lifting of a patient's legs - any other use may damage the bed frame.

## 8.12 Lockout Function

The handset is supplied with a lockout function which enables the carer to disable bed functions if they are deemed unsuitable for the occupant. The lockout function on the handset is to be used at the discretion of the carer.

To lock/unlock a function, turn the handset over insert the handset key provided into the recess and turn to the required position (clockwise to lock, anti-clockwise to unlock).

**Note: The handset functions are likely to be in the locked state when the bed is first installed. head down tilt function lockout is only available with the 10 button handset. For accessories please refer to Section 18.**

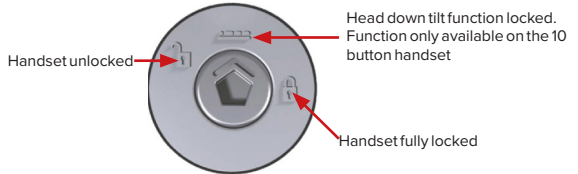

8.13.1 Locking function

As the key is rotated the light will extinguish/illuminate as determined by the lock state. **9 Button Handset (Standard)**

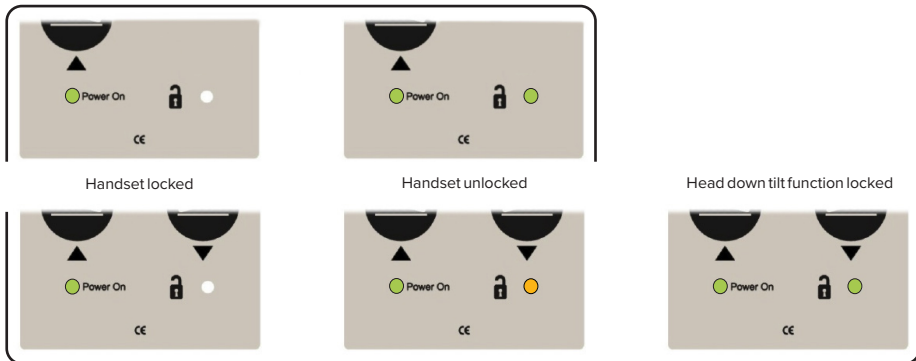

**10 Button Handset (Accessory)**

**Note: When head down tilt function is locked out and the bed is in the foot down tilt position the platform is levelled via the mattress platform raise/lower buttons, take the frame fully up or down until the platform is level.**



**Warning**

- Engage the lockout functions if a patient could be injured due to inadvertent motion of the mattress platform.
- If children, adults who lack capacity or even pets pose a potential risk of intentional or unintentional tampering with the bed the lockout function on the handset is to be used at the discretion of the carer.
- Consideration is to be taken with regards to the storage of the handset lockout key to minimise the risk of it being swallowed or posing a choking hazard to a baby, child, bed occupant or any other person.
- Consideration is to be taken when storing the handset lockout key to minimise the risk of unauthorised users changing the lock setting.



### **8.13 Installation/Preparing for Use**

Prior to operating the bed for the first time the following simple checks must be performed:

- Ensure the bed and all accessories are at room temperature.
- Ensure the bed has been cleaned and disinfected (see section 13).
- Ensure the brakes on the castors have been applied.\*
- Before locking the castors, ensure they are aligned so that they run parallel to the length of the bed and inboard so they do not present a trip hazard.
- Ensure the mains cable is plugged into an appropriate mains socket.
- The handset may be in a locked or unlocked state, ensure it is set according to the patient requirements (see section 9.4 for handset operation).
- Using the handset ensure the bed is level (see section 9.4 for handset operation), before positioning the bed according to the patient's needs.

\* All four castors should be locked to prevent inadvertent movement of the bed. If the bed will be used in tilt, it is advisable to unlock the foot end castors whilst operating the function to prevent the castors from dragging over the floor during the tilting motion. Once the required tilt position is reached, all castors should be locked.



**Warning**

- Ensure the mains cable is plugged into an appropriate power source at all times.
- Ensure the electrical cables are not in tension, paying particular attention to the mains cable when the bed/backrest travel up/down.
- Ensure that all cables and the handset are clear of all moving parts to prevent damage to the electrical components.
- Inappropriate handling/positioning of the mains cable could cause kinking or shearing of the cable which may lead to exposed live wires - risk of electrocution.
- Drive DeVilbiss Healthcare Ltd. recommend the bed is left in its lowest position when the patient is unattended in order to reduce the risk of injury due to a fall.
- Before operating the bed ensure the patient is positioned appropriately ensuring all limbs are clear of moving parts to reduce the risk of patient injury.
- Precautions are to be taken when routing cables from external equipment around the bed to ensure that they do not become crushed, trapped or damaged - damaged cables could pose a risk of electrocution/fire.
- A CE marked extension cable must only be used when it is not possible to reach a wall socket with the equipment mains cable – contact Drive DeVilbiss Healthcare Ltd. or the equipment provider for information regarding the safe use of extension cables.
- If an extension cable is used never overload it by plugging in appliances that together will exceed the maximum current rating stated for the extension cable – risk of fire.
- ‘Block’ adaptors should not be used.
- Ensure multiple socket outlets are not positioned under the bed frame - liquids that leak onto such a socket could pose an electrical/fire risk.
- Any electrical component that is part of the bed frame or associated ancillary equipment that is found to be damaged must be removed from service immediately and replaced - damaged electrical components could pose a risk of electrocution/fire.
- Consideration is to be taken in the positioning of the bed cables and handset cable to minimise the risk of accidental strangulation resulting from entanglement of the bed occupant or any other person.



**Warning**

- After assembly of the bed there should be no parts remaining, however consideration is to be taken in the event of spare components (pins, clips etc.) being evident to minimise the risk of them being swallowed by the bed occupant or any other person; this could pose a choking hazard.
- Keep the bed away from sources of heat and naked flames (e.g. cigarettes, fireplaces, electric fires, fan heaters etc.) – Close proximity could damage the electrical system and/or pose a fire hazard.
- If the bed is being used in conjunction with a hoist ensure the under bed clearances are checked before lowering the bed to minimum height - risk of frames clashing.



**Caution**

- If the bed has come from a storage/transport temperature environment near to the minimum or maximum values stated allow the bed to adjust to room temperature for a minimum of 2 hours prior to plugging the bed into the mains supply - risk of electrical system damage if operated outside of the recommended temperatures.
- Do not use the side rails to move the bed – side rail/bed frame could be damaged.
- Avoid placing the bed frame in direct sunlight - direct sunlight could damage the electrical system and/or cause the bed to fade in colour over time, including fading of the bed labelling.
- Avoid placing the bed frame in a moisture rich environment – prolonged exposure to moisture could damage the electrical system and/or have a detrimental affect on the bed frame components.
- Special care should be taken when fitting an air mattress to the bed as incorrect fitting could damage the bed frame.
- The bed is not designed to run off battery power for long periods (with BED/BATTERY/S only) and should always be plugged into the mains supply during normal use - allowing the battery to discharge fully may impair its performance.
- When the bed is operated, ensure that obstacles such as over bed tables and other furniture are not causing an obstruction.
- Ensure the bed is positioned an appropriate distance from walls/ other furniture to prevent equipment damage when operating the bed (particularly when operating in tilt)
- Special precautions regarding EMC need to be taken, the bed is to be installed and put into service according to the EMC information provided in section 17.

## 9. OPERATION OF THE BED

---

### 9.1 Operational Limits

- Ambient temperature: +10°C to +40°C
- Humidity: 30% - 75%
- Atmospheric pressure: 800 hPa to 1060 hPa (altitude ≤ 2000m)

### 9.2 Brake System

The bed has four braked castors.

- To apply the brakes: Press the brake pedal down on each of the four castors using the foot - Drive DeVilbiss Healthcare Ltd. recommend appropriate footwear is worn to operate the pedal safely.
- To release the brakes: Push the brake release pedal down on each of the four castors (located on top of the castor).

When the bed is in use Drive DeVilbiss Healthcare Ltd. recommend all brakes are applied in normal use – Foot end castors should be unlocked if the tilt function is to be used.

### 9.3 Operating the Side Rails (Where Fitted)



**Warning**

- Ensure the side rails are locked in place at all times when in the raised position to prevent injury or entrapment.
- When raising/lowering the side rails ensure they are free from limbs, to prevent injury or entrapment.
- When exiting the bed the side rails are not to be held on to - risk of finger entrapment/crushing hazard if weight of patient's legs allows side rails to flex downwards and close the gap between the rails.



**Caution**

- Do not use the side rails to move the bed – side rail/bed frame could be damaged.
- Do not use the side rails as a positioning or lifting aid – side rail and/or bed frame could be damaged.
- When lowering, do not drop the side rail - side rail and/or bed frame could be damaged.

This information refers to the operation of the integral wooden side rails. For details of how to operate a different type of side rail, refer to your side rail instructions for use.

To lower the integral side rails:

1. Lift one end of the top side rail upwards.
2. Depress the release latch at the raised end of the side rail whilst holding the side rail up.
3. Gently lower the side rail until fully down at one end. The release latch can be released after the side rail has begun to lower.
4. Repeat the process at the opposite end of the bed.

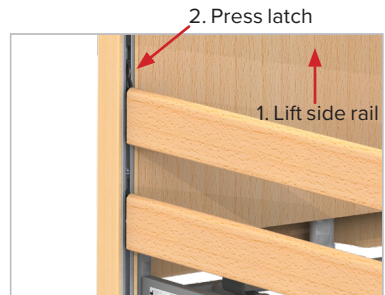

9.3.1 Lowering the side rails

To raise the integral side rails:

1. Lift the upper side rail until it is heard to latch into position at the top height at both ends of the bed.

### 9.4 Electrical Operation

The bed is supplied with an easy to use handset. The handset may be operated by the occupant or carer. If the carer is to operate the bed ensure that the occupant is made aware of the action(s) about to take place.

Holding down of the relevant button causes the desired function to operate, releasing the button causes the operation to terminate and all movement to stop.



- Ensure a risk assessment is undertaken to ensure the suitability of the occupant using the handset.
- The handset cable must also be considered in regards to the risk of accidental strangulation of the bed occupant or any other person - If the cable introduces an unacceptable risk it is recommended that the handset is removed from the bed.
- Before lowering the bed ensure no one is in close proximity to the underside of the bed frame - risk of crushing.
- The mains plug is the disconnect device for the means of isolating the bed from the mains supply, the plug must be accessible at all times. If the mains plug is inaccessible separate the connection halves of the mains cable (see 8.3.4).
- Before lowering the bed ensure feet/limbs are kept away from the castor pedals - risk of crushing (BRAD/LOW/COLOUR only).
- As standard, the handset provided omits a head down tilt function for safety reasons. If the head down tilt function is required a replacement handset can be purchased featuring this function. Please refer to Section 18 for the part code, refer to the contact information in Section 2 to order or to request further information - Drive DeVilbiss Healthcare Ltd. recommend the use of the standard handset when the bed is being used in a domestic environment.



- If the bed is continuously used for an extended period of time and it exceeds the duty cycle the control box may become temporarily disabled or irreparably damaged – see section 16.2 for further detail.
- Before lowering the bed ensure the area underneath is free from objects/obstructions - risk of damage to the bed and object/obstruction.
- The backrest is only to be used for the raising and lowering of the patients back - any other use may damage the frame.

9 Button Handset (Standard)

10 Button Handset (Accessory)

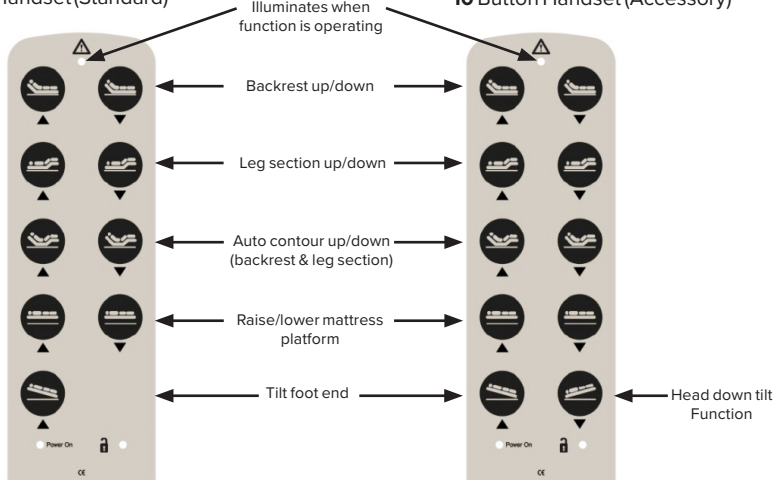

When the bed is in the foot down tilt position (or head down tilt if a 10 button handset is used) the platform is levelled via the mattress platform raise/lower buttons to take the frame fully up or down until the platform is level.

## 9.5 Side Rail Lockdown Functionality

The bed comes with side rail lockout functionality as standard. There are four lockouts per bed, each of which can be found in the corner post channels.



### Warning

The side rail lock is intended as a lockdown mechanism only. Under no circumstances should the lock be used to hold the rails in the raised position.



9.5.1 Grub Screw Out



9.5.2 Grub Screw In

To lock the side rail down:

- Turn the grub screw anti-clockwise so that it protrudes from the channel, leaving sufficient thread in the bed end that it does not fall out (See 9.5.1).
- Repeat the procedure for the opposite bed end.
- The grub screws will then stop the top slider from moving freely up the channel.

To unlock the side rail:

- Turn the grub screw clockwise until it sits flush with the back of the channel. (See 9.5.2).
- Repeat the procedure for the opposite bed end.

## 9.6 Uncovered Bed Ends

The Bradshaw range can be specified with uncovered bed ends. This allows the bed end actuators to be accessed without removing the cover boards.



**Warning**

The actuators should never be interfered with while the bed is plugged into the mains power supply or a battery backup facility is present and plugged into the control box. Only trained service engineers should ever make changes to the actuators and bed ends. Contact Drive DeVilbiss Healthcare Ltd. for more information.

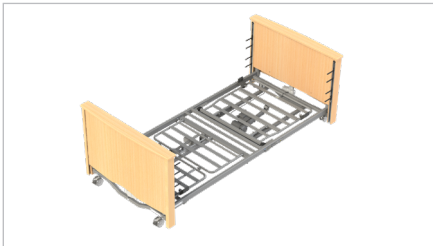

9.6.1 Bradshaw Low Height Bed

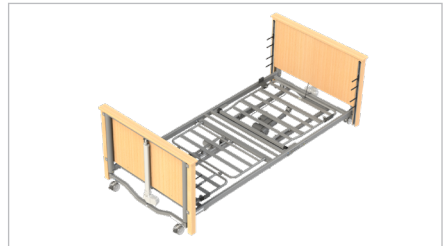

9.6.2 Bradshaw Low Height Uncovered Bed



9.6.3 Bradshaw Standard Height Bed



9.6.4 Bradshaw Standard Height Uncovered Bed



## 10. ASSEMBLY ONTO THE TRANSPORT STANDS



### Warning

- Before attempting to assemble the bed onto the transport stands ensure these instructions have been read and fully understood.
- Ensure a risk assessment in line with local health and safety policy is undertaken to ensure that staff are not put at risk when performing assembly activities.
- Take care when assembling the bed onto the transport stands, the sections are of considerable weight (see section 15).

### Side Rails (if fitted)

- Raise/lower the mattress platform to approximately its middle height, ensuring the platform is level.
- Remove the cap head screw from each side rail channel.
- Carefully lower the side rail (the lower slide block will partially protrude from the channel).
- Unlatch the slide blocks at one end of the bed and, whilst lowering and supporting the side rails, carefully remove the slide blocks from the bottom of the channel.
- Whilst supporting the side rails, remove them from the slide block fingers at both ends, and place them on the floor, then reinsert the slide block assemblies into the side rail channel for storage. Refit the screw to the bottom of the side rail channel.



10.1 Slide block assembly

### Electrics

- Flatten and lower the bed to its minimum height (see section 9.4).
- Unplug the mains cable from the mains socket.
- Remove the retaining clips from the control box.
- Unplug the bed end and leg section actuator cables from the control box.
- Detach the cables from the cable routing clips on the underside of the bed.

### Bed Frame

- Using the cable ties that first came with the bed, secure the moving parts of the backrest and leg section to the bed frame halves. See section 7 for cable tie locations.
- Retrieve the transport stands from storage.
- Release the castor brakes.
- Loosen the grub screws (using the Allen Key provided) in the middle of the bed frame and remove the clevis pins, 'R' clips and spacers from the central joint.
- Whilst supporting both halves of the bed frame near the centre of the bed, split the bed in half by carefully pulling the sections apart and gently lower onto the floor - this may be considered easier with the help of a second able bodied person.

- Apply the castor brakes on the bed ends.
- On one bed end, loosen both grub screws with the Allen key provided.
- Whilst supporting the bed end, lift the platform half away from the bed end and gently position both sections appropriately.
- Repeat for the remaining half of the bed.

### **Assembling onto the Transport Stand**

- Slide both transport stands onto one bed end, taking care to ensure the brackets are both oriented correctly.
- Tighten the grub screws with the Allen key provided to lock into position.
- Slide the remaining bed end onto the transport stands and tighten both remaining grub screws to lock into position (10.2).



10.2 Transport stand base

- Before lifting the backrest and leg section frames, ensure the moving parts have been secured with cable ties or similar.
- Carefully lift the leg section and lower onto the slotted vertical tubes of the transport stands, ensuring the electrics are facing inwards. The leg section must be fitted to the transport stands before the backrest section (10.3).



10.3 Leg section on transport stands

- Carefully lift the backrest section and lower the spigots through the larger open tubes on the transport stands, ensuring the electrics are facing inwards.

- Tighten all grub screws.

- Insert the clevis pins through the transport stands and leg section and secure with the 'R' clips and spacers.

- Ensure the instructions for use, control box clip and handset locking key are safely stored, and that all cabling is neatly wrapped around the relevant bed sections and is not dragging on the floor or under excess tension (10.4). See Section 7 for cable tie locations.



10.4 Bed on transport stand



\* Assembly applicable to Uncovered Bradshaw variant.



**Warning**

- The bed must never be moved on the transport stand without all sections locked into place as mentioned above - risk of bed collapse.
- Ensure moving parts have been secured with the re-useable cable ties provided - risk of sections moving in an uncontrolled manner.

## 11. POWER FAILURES

---

The bed does not have battery backup functionality unless you have purchased the battery backup accessory (BED/BATTERY/S). This can be identified by a battery box fastened to the backrest mattress platform. In the event of a power failure the bed will not function, resulting in the backrest and/or leg section remaining in the last position being used (for example, a raised position).

The backrest and leg section are operated via two individual actuators that are located underneath the mattress platform. If either the backrest or leg section actuator is raised in the event of a power failure and needs to be lowered:

- Locate the actuator supporting the relevant section.
- Hold/support the section - It is recommended that two carers support the section\*.
- Remove the pin that holds the top of the actuator in place, allow the actuator to gently swing down whilst still connected at the base.
- Gently lower the section(s) to the flattened position.
- Function that has been manually lowered should be locked out on the handset until the actuator is reattached.



**Warning**

\* If the section is to be lowered with a patient in the bed, a risk assessment should be carried out to determine the weight applied to the backrest and whether it is possible to lower the section safely. It is recommended that two carers support the section prior to lowering. When the pins are removed there is nothing supporting the section, the carer(s) holding the frame must be ready to support the weight on removal of the pin.

For beds that feature battery backup functionality, the bed can be operated normally via the handset in the event of a power failure. The bed functions may operate at a slower speed when the bed is operating from the battery.

## 12. BATTERY CHARACTERISTICS (BED/BATTERY/S ONLY)

---

The internal battery trickle charges whilst the bed is plugged into the mains supply to keep it in a continually charged state, the bed will continue to operate normally whilst charging. There is no audible or visual signal to identify when the battery is charging or in use.



**Warning**

Ensure the battery is not exposed to direct sunlight or a secondary heat source - Direct heating of the battery via an external source could pose a risk of fire or cause an explosion.



**Caution**

The battery is not to be used in normal use (i.e. bed disconnected from the mains supply) - battery life expectancy may be reduced.

## 13. DECONTAMINATION

Infection control and routine cleaning must be carried out in accordance with your local infection control policy or regulatory body.

It is advisable to remove any accessories that are fastened to the bed. These instructions apply to the bed and all accessories, excluding pads and mattresses.



**Warning**

- Always disconnect the bed from the main power supply prior to cleaning.
- Ensure all ports on the electrical system (control box and actuators) have cable plugs fully inserted to maintain the IP rating.
- Regular cleaning and disinfection of the bed frame and relevant accessories will help to prevent the risk of infection to the occupant and/or carer.
- Prior to transferring the bed frame/accessory to another user ensure it has been cleaned and disinfected using the method as detailed below to help prevent the risk of cross infection.

### 13.1 Cleaning and Disinfection Guidelines

#### General Cleaning:

- The bed should be cleaned by starting with the cleanest parts of the bed and systematically moving to the dirtiest parts. Extra care should be taken around areas where excess dirt or dust may gather.
- The cloth should be changed during the cleaning process if it becomes soiled.
- Wipe down with a clean cloth moistened with a mild detergent and dilute with warm water (40°C).
- Rinse with cold, clean water and a clean cloth, and allow to fully dry before use.

#### Decontamination:

- Mop up any fluid with paper towels.
- Wipe bed down using cold clean water.
- Wipe down with a 0.1% Chlorine solution (1,000ppm) in cold water.
- Rinse with cold clean water and a clean cloth and allow to fully dry before use. Always ensure the cleaned parts are allowed to dry before putting the mattress back in place.

In cases of blood spills or other bodily fluids it is recommended that a 1% Chlorine solution (10,000ppm) is used instead.

**Note: If any of the stages stated above are omitted or combined it will reduce the effectiveness of the clean.**



**Caution**

The use of neat bleach or similar surface cleaners is not recommended as damage may be caused to the cleaned surfaces.

### **13.2 Steam Cleaning**

The Bradshaw can be dry steam cleaned, the individual manufacturer's instructions should be followed when using a steam cleaner and the following precautions observed:

- Avoid directing steam directly at electrical components and reduce steam pressure when cleaning near electrical items and connections.
- Avoid directing steam directly at wooden components and reduce steam pressure when cleaning near wooden components.
- Use soft brushes and wiper cloths as recommended by the steam cleaner manufacturer.
- Do not use excessive force or steam pressure on labels.
- Ensure the bed is dry and all debris from the cleaning process has been removed prior to reuse.
- Ensure all electrical functions operate as normal once the bed has been cleaned and dried.



**Caution**

Do not use high pressure hoses on the bed as they could cause damage to the electrical components.

## 14. MAINTENANCE

### 14.1 General Inspection

Drive DeVilbiss Healthcare Ltd. recommends that authorised personnel perform frequent visual and operational inspections. If there are any signs of damage or the bed is not performing as it should withdraw it from service until the bed has been repaired and is fit for use again.

As a minimum, on a monthly basis check to ensure that:

- The bed operates as per its intended purpose.
- All parts are present.
- All fixtures and fittings are tight.
- The frame is mechanically sound, with no cracking, particularly around welded areas.
- No parts show signs of excessive wear.
- The electrical components display no sign of damage - if so turn off at the mains and remove the bed from use immediately.
- The bed is cleaned following the guidelines in these instructions for use.

### 14.2 Fault Finding

Listed below are a set of electrical faults that may occur within the service life of the bed. If a fault does occur please try the following suggestions, as these may help in diagnosing the fault.

Fault	Possible Cause	Remedy
Electrical function(s) do not work	Functions locked out on handset	Unlock function(s) - see section 8.12
	Mains cable halves not connected or plugged into the wall	Check to see if the mains cable is plugged into the wall and both halves are connected
	Actuator/handset cables not plugged in	Check plug connections on the control box and actuators
	Damage to electrical component(s)	Turn off at the mains and contact an approved service engineer
	Heavy load on the bed and the duty cycle has been exceeded	If the control box has exceeded its duty cycle, permanent damage will have occurred, a replacement control box will be required
Electrical function(s) working slowly	Heavy load on the bed	Remove load
	Bed is operating on battery power (BED/BATTERY/S only)	Check mains cable is plugged in at both ends and turned on (power light will be visible on control box)
Incorrect functions work when handset operated	Cables plugged into incorrect ports on control box	Review cables and graphic on control box to assess if connections are correct

### 14.3 Servicing

Only authorised service personnel or Drive DeVilbiss Healthcare Ltd. service engineers should carry out repairs or service activities. Failure to do so may result in the manufacturer's warranty becoming void. **The bed must be serviced once yearly, as a minimum.**



**Warning**

- Failure to carry out the following checks at the stated frequency could negatively influence the essential performance of the bed and as a result put the patient at risk.
- Always disconnect the bed from the mains power supply prior to performing any maintenance procedures (when not checking electrical functions).
- Modification of the bed frame is not allowed without the permission of Drive DeVilbiss Healthcare Ltd. - a hazard could be introduced.
- The bed should be vacated by the patient before any maintenance or inspection takes place. If it is not possible due to the patient's mobility, a risk assessment should be carried out, and if deemed safe to proceed, care should be taken for the service engineer to avoid contact with the patient when working on electrical items.
- Only Drive DeVilbiss Healthcare Ltd. approved components, specified for the Bradshaw and Bradshaw Low beds, should be used - if in doubt contact Drive DeVilbiss Healthcare Ltd. or your local distributor.
- Electrical system components are only to be replaced by authorised service personnel or a Drive DeVilbiss Healthcare Ltd. service engineer.
- Never attempt to re-wire any components.
- Battery packs may emit an increased amount of flammable gas as they age - risk of explosion/fire. Drive DeVilbiss Healthcare Ltd. advise that batteries are replaced every 4 years or sooner (BED/BATTERY/S only).

To maintain the bed's essential performance the following checks must be performed:

- Check that all electrical functions operate correctly on the handset.
- Check that all electrical components and cables are in good condition - If not turn off at the mains and remove bed from use until replacement parts are available.
- Check the retaining clip is fastened to the control box, securing the electrical cables in place.
- Check that all four mattress side retainers are present, any missing retainers should be replaced before the bed is used.

- Check that all nuts, bolts and fasteners are tight and that none are missing or incomplete.
- Check that all grub screws are present.
- Check that the backrest and leg rest functions (angle and height adjustment modes) work correctly.
- Check the castors lock/unlock correctly and that when locked the castors do not swivel or roll.
- Check that all product labels are present and intact.
- Check that the frame is mechanically sound with no cracking around the welds, bending of tubes etc.
- Check wooden components are free from cracks and deformation.
- Raise and lower the side rails. Check that they move smoothly.
- If side rails are fitted, check that the lock on the side rails automatically engages when the side rails are raised.
- If any gaps appear to be outside of specification remove the bed from use until the dimension of the gap in question has been confirmed.
- For beds fitted with battery backup (BED/BATTERY/S) check that the battery is capable of suitably powering the bed.
- If in doubt about the correct replacement of a component contact Drive DeVilbiss Healthcare Ltd. or your local distributor.
- Refer to the service manual for part codes and assembly detail. Copies are available from Drive DeVilbiss Healthcare Ltd. Contact details can be found in section 2.

## **15. DISPOSAL OF PARTS**

- When the bed frame, any associated accessories and/or the electrical system have come to the end of its useful life, follow local recycling and W.E.E.E. (waste electrical and electronic equipment) policies - For further information contact Drive DeVilbiss Healthcare Ltd. (see section 2).
- The electrical system on the bed frame is not to be disposed of in general municipal waste. Some of the electrical components could be harmful to the environment and where viable the components can be recovered and reused/recycled.
- The steel, wood and plastic components are also to be separated and disposed of following the local recycling policy as these can also be recovered and recycled.



**Warning**

The bed and any associated accessories are to be decontaminated before disposal to avoid risk of cross contamination.

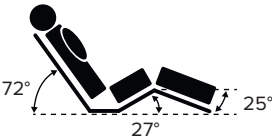

## 16. SPECIFICATION

16.1 Bed Data		BRADSHAW	BRADSHAW LOW	BRADSHAW UNCOVERED	BRADSHAW LOW UNCOVERED
Product code		BRAD/STD/LOAK BRAD/STD/3/LOAK*	BRAD/LOW/LOAK BRAD/LOW/3/LOAK*	BRAD/LOW/ LOAK/UC	BRAD/STD/ LOAK/UC
Overall length	2215mm			2156mm	
Overall width	1056mm				
Mattress platform height	386- 808mm	192-614mm	386- 808mm	192-614mm	
Under bed clearance <small>(to underside of frame when bed is lowered)</small>	339mm	146mm	339mm	146mm	
Under bed clearance <small>(to underside of actuator when bed is lowered)</small>	213mm	21mm	213mm	21mm	
Mattress platform length	1990mm				
Mattress platform width	905mm				
Foot down tilt	0 - 11°				
Mattress platform angles <small>(max)</small>					
Safe working load	215 kg (34 stone)				
Maximum patient weight	178 kg (28 stone)				
Product weight <small>(on transport stand)</small>	83 kg				
Part weights	Leg section	16.0 kg			
	Backrest	22.0 kg			
	Bed ends <small>(each)</small>	21.0 kg			
Application environment	3 & 4				
Shock and vibration	To be used on a flat level floor <small>(e.g. vinyl/carpet/laminate based)</small>				
UV	Intended for indoor use only				

The Bradshaw has a Light Oak facade as standard, but is available in five colour options: Use **LOAK** for Light Oak, **ASH** for Ash, **BECH** for Beech, **ELM** for Elm and **WALN** for Walnut, when ordering your bed.

\* Note Bradshaw variants are supplied with 2 bar side rail finger kits as standard. Variants showing ' /3 ' in their code include the 3 bar finger kits, and are therefore compatible with the 3 bar side rails as default. Specification information for both variants are the same and accessories are shared between the two beds, only differing in how they are originally supplied.



**Warning**

- As standard, the handset provided omits the head down tilt function for safety reasons. If head down tilt functionality is required, a replacement handset can be purchased featuring this function, however the customer should be aware that the Trendelenburg angle requirements EN 60601-2-52 are not achieved. Please refer to section 18 for the part code, and to the contact information in section 2 to order or to request further information - Drive DeVilbiss Healthcare recommend the use of the standard handset when the bed is being used in a domestic environment.
- The Bradshaw Low does not meet the upper height and under bed clearance requirements of EN 60601-2-52, if patient requirements are such that the height range is deemed to pose a potential hazard the Bradshaw should be used instead, please refer to the contact information in section 2 to request further information.

## 16.2 Electrical Data

	Power Supply Plug
Voltage in:	100-240V, 50/60Hz
Current in:	2A-1.2A
Electric shock protection:	Class II

Duty cycle:\*

10%

**2mins** of continuous use followed by **18 mins** not in use.

\* Electrically operated beds are intended to be operated intermittently rather than continuously. If the bed is operated continuously for up to 2 minutes it must then be left for at least 18 minutes before reuse to allow the electrical system to cool sufficiently. **If the bed is continuously used for an extended period of time and it exceeds the duty cycle the control box may become temporarily disabled or irreparably damaged.**

Safety standards:

EN 60601-1  
EN 60601-1-11  
EN 60601-2-52

Electrical shock prevention:



Applied parts:

Mattress platform  
Profiling sections  
Bed ends  
Handset  
Side rails

Liquid ingress protection:

IPX4 - Splash resistant

Battery backup:

Individual battery non replaceable  
(Contact bed provider for battery part code)

Noise level:

59,3 dB(A)

Environmental conditions:

	Operational Limits*	Transport/Storage Limits*
Ambient Temperature	+10°C to +40°C	-20°C to +50°C
Humidity	30% - 75%	30% - 75%
Atmospheric Pressure	800 to 1060hPa	800 to 1060hPa
Altitude	≤ 2000m	≤ 2000m

\* Always ensure the bed is brought up/down to room temperature before plugging in and operating - Drive DeVilbiss Healthcare Ltd. recommend the bed is left for a period of two hours or more to reach room temperature.

When operating the bed in an ambient room temperature of 40,0 °C the mains power supply plug can heat up to a maximum temperature of 66,5 °C. In such conditions, prior to unplugging or touching the power supply plug ensure the bed is not operated for 2 hours, to allow the plug to cool down, and if safe to do so switch off at the wall. In the event of needing an immediate disconnection from the mains supply, if you suspect that the power supply plug may be hot protect your hands with a thick cloth or protective gloves.

When operating the bed in an ambient room temperature of 40,0 °C if any of the actuators or the control box need to be touched ensure that any contact is for no more than 5 minutes. If the temperature of the actuators or control box begins to feel uncomfortable let go immediately. If there is a specific need to contact these components in such conditions ensure the bed is not operated for 2 hours, to allow the components to cool down, and if safe to do so switch off at the wall.

When operating the bed in an ambient room temperature of 40,0 °C ensure the handset is held for no more than 10 minutes. If the temperature of the handset begins to feel uncomfortable let go of it immediately.

## **17. ELECTROMAGNETIC COMPATIBILITY (EMC)**

The Bradshaw/Bradshaw Low electrical system has been designed to meet the EMC requirements of EN 60601-1-2 however it may still be affected by or emit harmful radio frequency (RF) energy. The RF emissions from the electrical system are very low and are not likely to cause any interference to nearby electronic equipment, however interference to sensitive equipment is still possible. Likewise if the immunity limits of the electrical system are exceeded the system may be seen to operate abnormally.

If the bed or any alternative equipment is found to be operating abnormally turn off the piece of equipment that is believed to be causing the interference (if possible) to identify the source of the RF energy. Once identified mitigation measures are to be taken, such as the separation distances being increased and/or the device(s) being re-orientated.

If the bed continues to operate abnormally turn off at the mains supply and contact Drive DeVilbiss Healthcare Ltd. or your local distributor (see section 2).

For specific emissions and immunity information relating to the bed, please contact Drive DeVilbiss Healthcare Ltd or your local distributor (section 2).



**Warning**

- The bed should not be used adjacent to or stacked with other medical electrical equipment, where viable. If adjacent or stacked use is necessary, the bed and associated medical electrical equipment should be observed to verify normal operation - if not taken in to account, abnormal operation could occur.
- Use of accessories and cables other than those specified or provided by Drive DeVilbiss Healthcare could result in increased electromagnetic emissions or decreased electromagnetic immunity of the bed and result in improper operation.
- Portable RF communications equipment (including peripherals such as antenna cables and external antennas) should be used no closer than 30cm to any part of the bed (including its cables), otherwise a degradation in performance could result.

## 18. ACCESSORIES

NOTE: When ordering accessories please state the colour code in place of **COLOUR**.

SIDE RAILS AND SIDE RAIL PADS	CODE
<b>WOODEN RAIL ACCESSORIES*</b> Integral wooden side rails - no finger kits Wooden side rail pads Integral wooden extended side rails - no finger kits Wooden extended side rail pads Integral wooden side rail height extension Integral wooden side rail height extension kit ** Integral side rail finger kits (4 pack)	RAIL/W/NFK/COLOUR 1275/PS RAIL/W/NFK/EX/COLOUR 1275/PS/EXT RAIL/W/HE/EX/COLOUR RAIL/W/K/HEEX/COLOUR RAIL/FK
<b>WOODEN 3 BAR RAIL ACCESSORIES*</b> Integral 3 bar wooden side rail kit ** Wooden 3 bar side rail pads Integral 3 bar extended wooden side rail kit ** Wooden 3 bar extended side rail pads Integral 3 bar wooden side rail finger kits (4 pack)	3RAIL/KIT/COLOUR 1275/3RAIL/PS 3RAIL/KIT/EX/COLOUR 3RAIL/EX/PS 3RAIL/FK
SIDE RAILS AND SIDE RAIL PADS	CODE
<b>METAL DIPPED RAIL ACCESSORIES</b> Integral metal dipped side rails in silver Integral metal dipped side rail kit in silver ** Metal side rail pads Integral extended metal dipped side rails in silver Integral extended metal dipped side rail kit in silver ** Extended metal side rail pads Integral side rail finger kits (4 pack)	RAIL/M/D/S RAIL/M/KIT/D/S SOLITE/PRO/SR/PAD RAIL/M/D/EX/S RAIL/M/KIT/D/EX/S SOLITE/PRO/SR/EXT/PAD RAIL/FK
<b>METAL STRAIGHT RAIL ACCESSORIES</b> Integral metal non-dipped side rails in silver Integral metal non-dipped side rail kit in silver ** Metal side rail pads Integral extended metal non-dipped side rails in silver Integral extended metal non-dipped side rail kit in silver ** Extended metal side rail pads Integral side rail finger kits (4 pack)	RAIL/M/ND/S RAIL/M/KIT/ND/S SOLITE/PRO/SR/PAD RAIL/M/ND/EX/S RAIL/M/KIT/ND/EX/S SOLITE/PRO/SR/EXT/PAD RAIL/FK
<b>METAL RAIL EXTENSIONS</b> Integral metal side rail height extension Integral metal side rail height extension with removable foot section Integral metal side rail height extension pads	RAIL/M/HEX/S RAIL/M/HEX/RF/S SOLITE/PRO/SR/HE/1/PAD

\* Integral wooden side rail accessories are available in the following choice of colours:  
Standard Wood Finish: Light Oak (**LOAK**)

Other Wood Finish Options: Beech (**BECH**), Ash (**ASH**), Elm (**ELM**), Walnut (**WALN**)

\*\* Side rails highlighted as such contain finger kits. Finger kits not included as standard.

Please note Bradshaw Standard, Low and Uncovered bed variants are supplied with finger kits as standard. Ensure the correct code is used when ordering accessories.

GRAB HANDLES	CODE
Standard grab handle	1210/GRAB
Short grab handle*	1216/GRAB

\* 1216/GRAB is incompatible with side rails fitted to the bed. If side rails are required, please order 1210/GRAB.

SIDE RAILS AND SIDE RAIL PADS	CODE
<b>OTHER</b>	
Grange side rail	GRANGE/SR
Grange side rail pads	1316/PS/CREAM



**Warning**

Accessories that have not been approved or designed for use with the bed are not be used - A hazard could be introduced due to product combination incompatibility.

OTHER ACCESSORIES	CODE
Lifting pole	SOLITE/LASER/LP/1
Transfusion pole	BED/DP
10 Button handset (head down tilt function)	CONTROL/130
Battery back up	BED/BATTERY/S
Bed extension (+165mm to mattress platform length)	BED/EX/S
Pump bracket	BRAD/PUMPBKT
Head and foot end pad	1275/HF/PAD
Cradle pad	SOLITE/PRO/EPS/PAD
Bradshaw bed end padded board**	BRAD/BE/PS/ <b>COLOUR</b>
Leg section ratchet	BED/RATCHET
Bed bump stop	BED/BUMPSTOP
Lifting pole socket, left hand***	BRAD/LPSOCKET/LH
Lifting pole socket, right hand***	BRAD/LPSOCKET/RH
Community bed plastic bag accessory	BAG/COM/BED/P

\*\* The Bradshaw bed end pads are available in the following colours:

Cream (CREM), Mushroom (MUSH), Chocolate Brown (CHOC), Ruby Red (RUBY), Sage Green (GREN), Slate Grey (GREY)

\*\*\* Left and right handed accessories are determined when laying supine in the bed. Characteristics of accessories can be found in their relevant instructions for use.

Please note cautions and warnings on page 49. The bed has been tested and approved with the following mattresses:

The below table highlights the current Drive DeVilbiss Healthcare mattress range. See section 18.1 for mattress compatibility tables. For more information contact Drive DeVilbiss healthcare (see section 2).

Mattress Type	Code	Length	Width	Thickness
<b>Foam Mattresses</b>				
<b>Standard Range</b>				
Softrest VE	MAT/SOFT/VE	1990mm	880mm	152mm
Softrest	MAT/SOFT			
Permafex ST	MAT/SOFT/CON			
MAT 10	MAT10BE	1980mm	900mm	127mm
MAT 20	MAT20BE			
MAT 30	MAT30HS			
<b>Premium Range</b>				
Permafex Plus	MAT/ACCL/PERM/PLUS	1990mm	880mm	152mm
Permafex HSF	MAT/ACCL/PERM/HSF			
Acclaim VE	MAT/ACCL/VE			
Memaflex	MAT/ACCL/MF			
<b>Foam Mattress Extensions</b>				
Softrest	MAT/SOFT/EX	180mm	880mm	152mm
Softrest (with straps)	MAT/SOFT/EX/STRAPS			
Acclaim VE	MAT/ACCL/VE/EX/STRAPS			
<b>Dynamic Pumps and Mattresses</b>				
Eros Dial Pump	EROS/PUMP	FOR USE WITH OVERLAY/MAT OR FULL/MAT		
Theia Digital Pump	THEIA/PUMP			
Drive Dynamic Overlay	OVERLAY/MAT	2000mm	990mm	127mm
Drive Air on Foam	FULL/MAT			
<b>Dynamic Systems</b>				
Simple Air	1001270001	2000mm	880mm	200mm
Atlas	DYN/DIG/ATLAS	2020mm		
Apollo	DYN/DIG/APOLLO	2000mm		
Artemis	DYN/DIG/ARTEMIS			
Athena	DYN/DIG/ATHENA		900mm	250mm

## 18.1 Mattress/Side Rail Compatibility Charts

Mattress Type	Code	RAIL/M/D/S	RAIL/M/ND/S	RAIL/M/HEX/S
<b>Foam Mattresses</b>				
<b>Standard Range</b>				
Softrest VE	MAT/SOFT/VE	✓	✓	✓
Softrest	MAT/SOFT	✓	✓	✓
Softrest Contour	MAT/SOFT/CON	✓	✓	✓
Permaflex ST	MAT/SOFT/PERM	✓	✓	✓
MAT 10	MAT10BE	✓	-	✓
MAT 20	MAT20BE	✓	✓	✓
MAT 30	MAT30HS	✓	✓	✓
<b>Premium Range</b>				
Permaflex Plus	MAT/ACCL/PERM/PLUS	✓	✓	✓
Permaflex HSF	MAT/ACCL/PERM/HSF	✓	✓	✓
Acclaim VE	MAT/ACCL/VE	✓	✓	✓
Memaflex	MAT/ACCL/MF	✓	✓	✓
<b>Foam Mattress Extensions</b>				
Softrest	MAT/SOFT/EX	✓	✓	✓
Softrest (with straps)	MAT/SOFT/EX/STRAPS	✓	✓	✓
Acclaim VE	MAT/ACCL/VE/EX/STRAPS	✓	✓	✓
<b>Dynamic Pumps and Mattresses</b>				
Eros Dial Pump	EROS/PUMP	✓*	✓*	✓
Theia Digital Pump	THEIA/PUMP	✓*	✓*	✓
Drive Dynamic Overlay	OVERLAY/MAT	✓*	✓*	✓
Drive Air on Foam	FULL/MAT	✓*	✓*	✓
<b>Dynamic Systems</b>				
Simple Air	1001270001	✓*	✓*	✓
Atlas	DYN/DIG/ATLAS	✓*	✓*	✓
Apollo	DYN/DIG/APOLLO	✓*	✓*	✓
Artemis	DYN/DIG/ARTEMIS	✓*	✓*	✓
Athena	DYN/DIG/ATHENA	✓*	✓*	✓
<b>Rails and Pads</b>				
Standard Grab Handle	1210/GRAB	✓**	✓**	-
Short Grab Rail	1216/GRAB	-	-	-
Padded Side	METAL/SR/PS	✓	✓	-
Padded Side	METAL/SR/HEX/PS	-	-	✓
Padded Side	BED/HF/PS	✓	✓	✓

Mattress Type	Code	RAIL/W/NFK/ COLOUR	3RAIL/KIT/ COLOUR	RAIL/W/HE/EX/ COLOUR
<b>Foam Mattresses</b>				
<b>Standard Range</b>				
Softrest VE	MAT/SOFT/VE	✓	✓	✓
Softrest	MAT/SOFT	✓	✓	✓
Softrest Contour	MAT/SOFT/CON	✓	✓	✓
Permaflex ST	MAT/SOFT/PERM	✓	✓	✓
MAT 10	MAT10BE	-	-	✓
MAT 20	MAT20BE	✓	✓	✓
MAT 30	MAT30HS	✓	✓	✓
<b>Premium Range</b>				
Permaflex Plus	MAT/ACCL/PERM/PLUS	✓	✓	✓
Permaflex HSF	MAT/ACCL/PERM/HSF	✓	✓	✓
Acclaim VE	MAT/ACCL/VE	✓	✓	✓
Memaflex	MAT/ACCL/MF	✓	✓	✓
<b>Foam Mattress Extensions</b>				
Softrest	MAT/SOFT/EX	✓	✓	✓
Softrest (with straps)	MAT/SOFT/EX/STRAPS	✓	✓	✓
Acclaim VE	MAT/ACCL/VE/EX/STRAPS	✓	✓	✓
<b>Dynamic Pumps and Mattresses</b>				
Eros Dial Pump	EROS/PUMP	✓*	✓*	✓
Theia Digital Pump	THEIA/PUMP	✓*	✓*	✓
Drive Dynamic Overlay	OVERLAY/MAT	✓*	✓*	✓
Drive Air on Foam	FULL/MAT	✓*	✓*	✓
<b>Dynamic Systems</b>				
Simple Air	1001270001	✓*	✓*	✓
Atlas	DYN/DIG/ATLAS	✓*	✓*	✓
Apollo	DYN/DIG/APOLLO	✓*	✓*	✓
Artemis	DYN/DIG/ARTEMIS	✓*	✓*	✓
Athena	DYN/DIG/ATHENA	✓*	✓*	✓
<b>Rails and Pads</b>				
Standard Grab Handle	1210/GRAB	✓**	✓**	-
Padded Side	WOOD/SR/PS	✓*	✓*	-
Padded Side	WOOD/SR/HEX/PS	-	-	✓
Padded Side	BED/HF/PS	✓	✓	✓





### Warning

- \* If the dynamic mattresses listed are used without side rail height extensions a patient risk assessment must be performed to ensure the gap between the top of the mattress and top of the side rail when raised is acceptable and will not introduce a hazard to the patient.
- \*\* Care must be taken when raising/lowering the RAIL/W/NFK/COLOUR, RAIL/M/KIT/D/S or RAIL/M/KIT/ND/S and their extended versions when used in conjunction with the 1210/GRAB, as the gap between the two components can introduce a finger entrapment hazard, positioning dependent.
- When using the bed with a dynamic mattress, the space introduced by cell compression at the mattress edge and the side rail (if fitted) is to be considered. A patient risk assessment must be performed to ensure an asphyxiation risk is not introduced by the patients face inadvertently sinking into the gap between the mattress and side rail.
- Ensure extension blocks are positioned centrally to the platform. If offset to one side a gap will be introduced between the extension block and the side rail, introducing a potential asphyxiation risk.
- When the height extension is used in conjunction with a foam mattress ensure patient ingress/egress is not compromised - if so, remove and refit the height extension as required during patient transfers.
- Care must be taken when raising the backrest when used in conjunction with the 1210/GRAB, as the gap between the two components can introduce a finger entrapment hazard with the mattress retainers, positioning dependent. Refer to INSTRUC/1210/GRAB for specific positioning detail.
- The use of a dynamic mattress, when the bed is in an extended state, is dependent on the outcome of an individual risk assessment. When using a Drive DeVilbiss mattress that is equipped with static head cells, the risk assessment is to take into account that these static cells will have moved down the bed if the foot end of the mattress is positioned at the foot of the extended bed.



### Caution

- It is essential that dynamic mattress straps are only attached to the moving parts of the profiling mattress platform. If the straps are incorrectly fitted around the main section of the mattress platform, serious damage could occur to various components of the bed. If in doubt contact your provider or Drive DeVilbiss Healthcare Ltd.
- Ensure the dynamic control box is not positioned on the side rails, risk of control unit falling off when side rails are lowered.
- When fitting a mattress, ensure it is seated inside the mattress retainers at the sides and foot end of the bed.

Drive DeVilbiss Healthcare Ltd. cannot be held responsible for any injury or incident which relates to the use of any product combinations not approved by Drive DeVilbiss Healthcare Ltd.

It is the carer's responsibility for selecting and fitting the products correctly and ensuring that the product combination is compatible.

## **19. SERVICE LIFE**

---

The Bradshaw bed has a service life of 10 years\* with the exception of:

- Battery pack: 1 year service life (BED/BATTERY/S only).

The accessories listed in section 18 have a service life of 10 years\* with the exception of:

- Side rail pads: 1 year service life
- Mattresses: Refer to the individual instructions for use

\*On the basis that the bed and its associated accessories are serviced and maintained in accordance with the information detailed in section 14 of these instructions for use and the individual instructions provided with the accessory in question.

## 20. WARRANTY

---

Drive DeVilbiss Healthcare Ltd. warrants that this product will perform in accordance with its specification and will remain free from defects in material and workmanship when used under normal conditions for a period of 3 years (which specifically is - 1 year full parts and labour, 2 further years parts only) from the date of purchase from Drive DeVilbiss Healthcare Ltd. and its subsidiary companies. If purchased from an authorised dealer or international distributor, the product is warranted for 1 year parts only. If a Drive DeVilbiss Healthcare Ltd. service contract is taken on the bed from year 1 (i.e. from the first service after 12 months from the date of purchase), a full parts and labour warranty is provided on the bed for the period in which the service contract is maintained, up to a maximum of 10 years from the date of purchase.

DRIVE DEVILBISS HEALTHCARE LTD. MAKES NO OTHER WARRANTIES, EXPRESS OR IMPLIED, AND ALL IMPLIED WARRANTIES OF MERCHANTABILITY, NON-INFRINGEMENT AND FITNESS FOR A PARTICULAR PURPOSE ARE HEREBY DISCLAIMED. IN NO EVENT WILL DRIVE DEVILBISS HEALTHCARE LTD. BE LIABLE FOR PUNITIVE, SPECIAL OR CONSEQUENTIAL DAMAGES, OR FOR AN AMOUNT IN EXCESS OF THE PURCHASE PRICE OF THE DEFECTIVE DRIVE DEVILBISS HEALTHCARE LTD. PRODUCT OR PRODUCTS.

Proof of purchase must be presented with any claim. Except as provided herein, this warranty will not apply to any Drive DeVilbiss Healthcare Ltd. products that have been (a) damaged by lightning, water, or power surges, (b) neglected, altered, abused, or used for a purpose other than the purpose for which they were designed, (c) repaired by you or any other party without Drive DeVilbiss Healthcare Ltd. prior written authorisation, (d) used in conjunction with a third party product or products not approved in advance by Drive DeVilbiss Healthcare Ltd., (e) damaged or failed by or attributes to acts of God, (f) damaged, caused by failure to follow instructions, or (g) otherwise used in a manner inconsistent with any instructions provided by Drive DeVilbiss Healthcare Ltd. The warranty explicitly exempts consumable items.

This warranty contains the entire agreement between you and Drive DeVilbiss Healthcare Ltd. with respect to any warranty matters, and supersedes any and all other written or oral statements, representations or agreements relating to the subject matter of this warranty.

In the event of a product defect during the warranty period you should contact your supplier, whether it be Drive DeVilbiss Healthcare Ltd., its subsidiary companies, authorised dealers or international distributors who will at their option unless otherwise provided by law; a) correct the defect by product repair within the terms of the warranty b) replace the product with one of the same or similar design or c) refund the purchase price. All replaced parts and products on which a refund is made become the property of Drive DeVilbiss Healthcare Ltd. Repaired or replaced parts and products are warranted for the remainder of the original warranty period. You will be charged for repair or replacement of the product made after the expiration of the warranty period.

This limited 3 year warranty gives you specific legal rights and you may also have other rights.

Drive DeVilbiss Healthcare Ltd. cannot be held responsible for any injury or incident which relates to the use of this bed in conjunction with accessories manufactured by companies other than Drive DeVilbiss Healthcare Ltd.

Drive DeVilbiss Healthcare Ltd. has a policy of continual product improvement and reserves the right to amend specifications covered in this document. No part of this document may be reproduced without the written approval of Drive DeVilbiss Healthcare Ltd.



CONTACT INFORMATION

Tel: +44 (0) 845 0600 333 Fax: +44 (0) 845 0600 334

Email: [info@drivedevilbiss.co.uk](mailto:info@drivedevilbiss.co.uk)

[www.drivedevilbiss.co.uk](http://www.drivedevilbiss.co.uk)



Drive DeVilbiss Healthcare Ltd., Holmfield, Halifax,  
West Yorkshire, HX2 9TN, United Kingdom

A member of the Drive DeVilbiss Group of Companies



Advena Ltd. Tower Business Centre 2nd  
Flr., Tower Street, Swatar, BKR 4013,  
Malta



Drive DeVilbiss Sidhil, 4 Trench Road,  
Mallusk, Newtownabbey, BT36 4TY,  
Northern Ireland



ORIGINAL INSTRUCTIONS  
INSTRUC/BRAD, 2024/05 - Rev10